

SECTION A - A

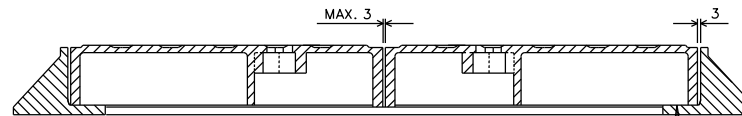

SECTION B - B

SURFACE IN CONTACT TO BE MACHINED TO CLOSE TOLERANCE

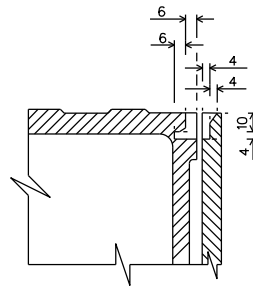

SECTION C - C

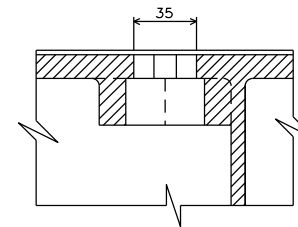

SECTION D - D

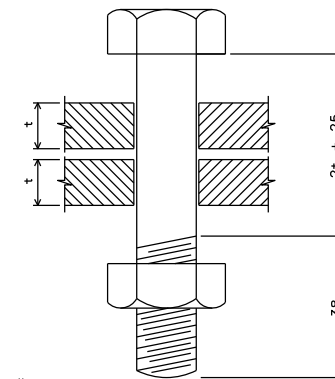

M16 BOLT  
NO WASHER TO BE USED

SCALE 1:1

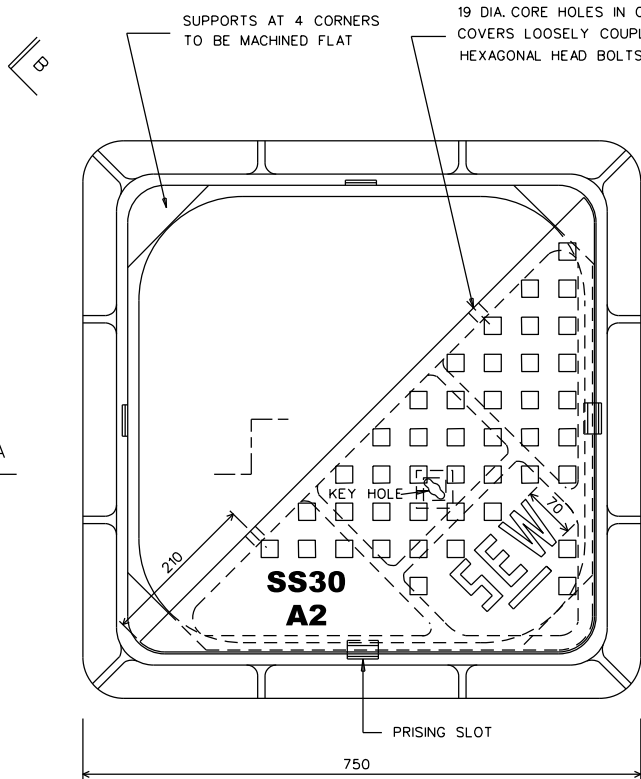

PLAN

HALF COVER REMOVED

SCALE 1:5

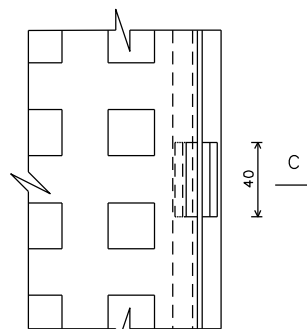

PLAN

DETAIL OF PRISING SLOT

SCALE 1:2

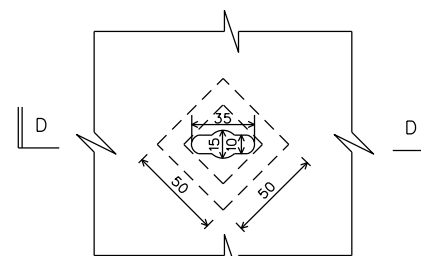

PLAN

DETAIL OF KEYHOLE

SCALE 1:2

NOTES :

1. MANHOLE COVER AND FRAME SHALL IN GENERAL COMPLY WITH S.S. 30.
2. ALL BOLTS AND NUTS SHALL BE OF STAINLESS STEEL.

1) SS30 AND GRADE ADDED TO MANHOLE COVER
2) FRAME THICKNESS ADDED
AMENDMENTS

ISSUED : APR 2005	SCALES
LAST REVIEWED : JAN 2019	AS SHOWN

# STANDARD MEDIUM DUTY MANHOLE FRAME AND COVER