

SECTION A - A

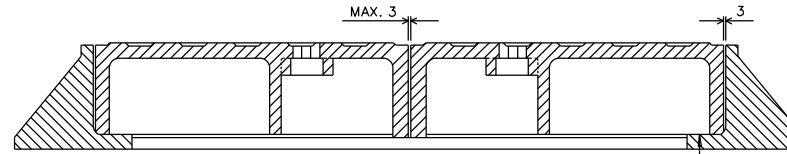

SECTION B - B

SURFACE IN CONTACT TO BE MACHINED TO CLOSE TOLERANCE

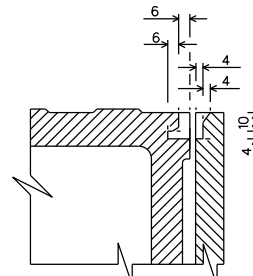

SECTION C - C

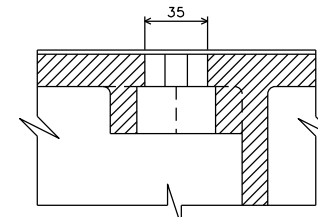

SECTION D - D

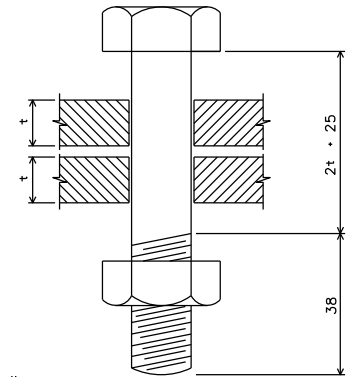

M16 BOLT
NO WASHER TO BE USED

SCALE 1:1

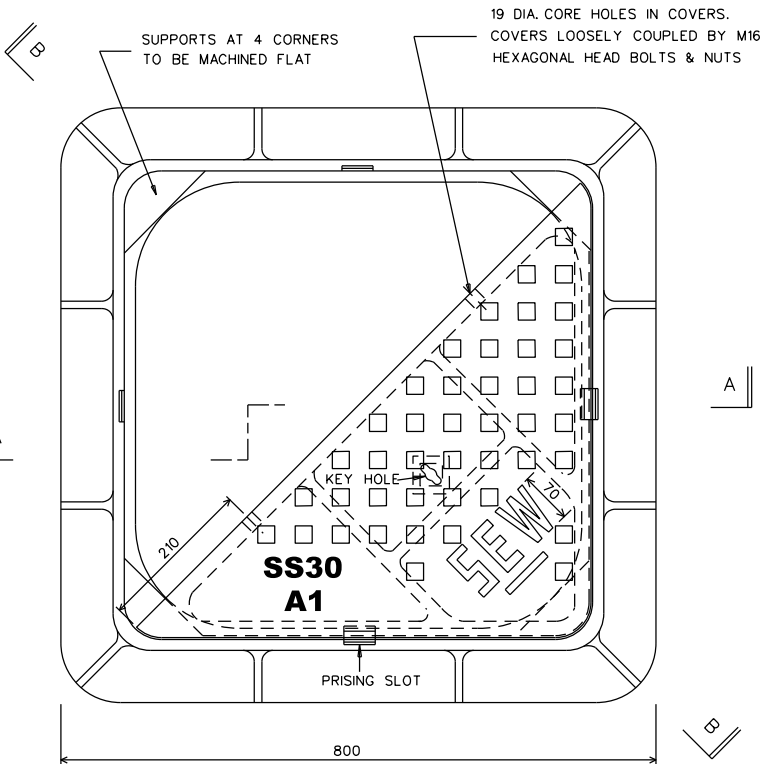

PLAN
HALF COVER REMOVED
SCALE 1:5

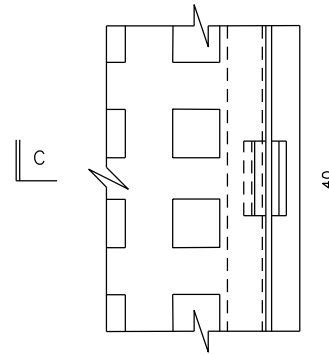

DETAIL OF PRISING SLOT
SCALE 1:2

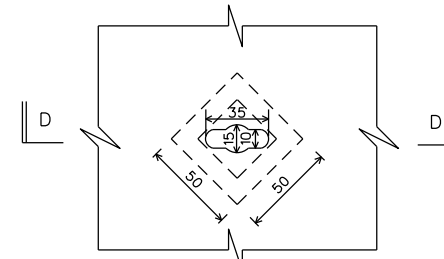

DETAIL OF KEYHOLE
SCALE 1:2

NOTES :

1. MANHOLE COVER AND FRAME SHALL IN GENERAL COMPLY WITH S.S. 30.
2. ALL BOLTS AND NUTS SHALL BE OF STAINLESS STEEL.

1) SS30 AND GRADE ADDED TO MANHOLE COVER
2) FRAME THICKNESS ADDED
AMENDMENTS

ISSUED : APR 2005	SCALES
LAST REVIEWED : JAN 2019	AS SHOWN

STANDARD HEAVY DUTY MANHOLE FRAME AND COVER